

Brio Weather Fold 4S - Inward Opening External Bi-Folding Doors - 5 + 1 System

Product Images

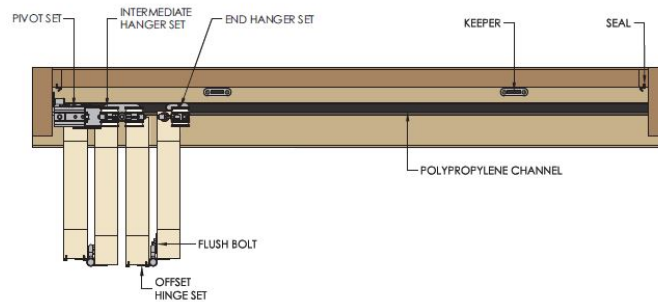
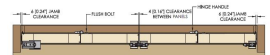
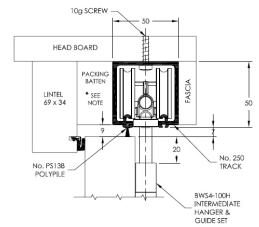
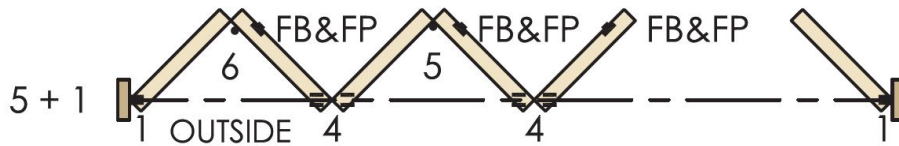

Short Description

- External bi-folding door kit for inward opening doors - 5 + 1 system.

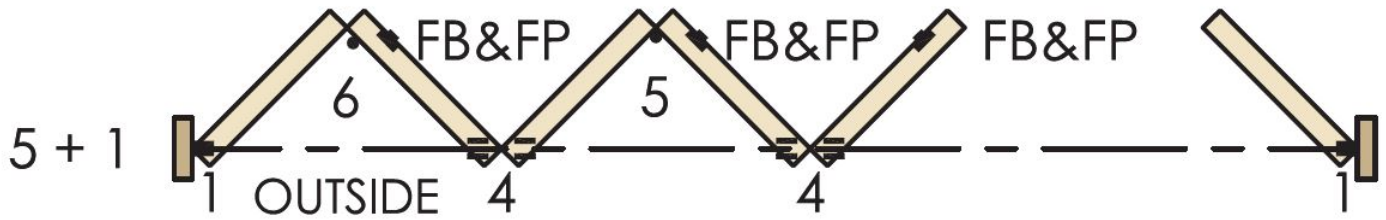

- The Brio Weatherfold series is recognised as the architectural standard in exterior folding door hardware.
- Brio Weatherfold 4s is a top hung exterior folding system which can handle panels up to 100kg with precision and ease.
- Large openings of 3.3m high and 16m wide can be achieved with 8 equal size panels folding seamlessly in each direction with inward or outward opening functionality.
- Suitable for external timber doors our kits pre-packed kits are supplied with brown weather seals and locking flush bolts, with matching hardware made from satin stainless steel.
- **Max Panel Weight:** 100kg
- **Max Panel Width:** 1000mm
- **Max Panel Height:** 3300mm
- **Panel Thickness:** 35mm - 68mm
- **Please note this product is the bi-folding door kit only. Doors are not included and must be purchased elsewhere.**

Description

5 + 1 Kit For Inward Opening Doors:

- Our Brio Weatherfold 4s - 5 + 1 system is supplied with enough hardware to allow for 5 doors to bi-fold either left or right.
- This kit allows for bi-folding doors to open **inwards** (into the building).

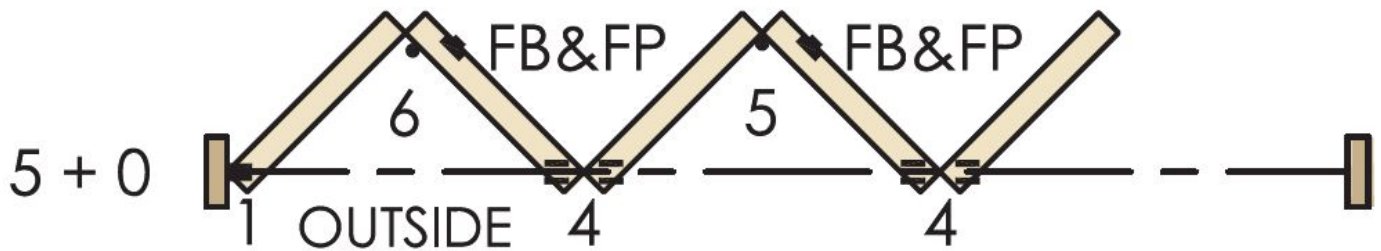

Maximum Door Panel Sizes (Per Door Leaf):

- **Panel weight** - 100kg
- **Panel width** - 1000mm wide - (this kit allows for a maximum of 2 x 1000mm wide door panels).
- **Panel thickness** - 35mm to 68mm.
- **Panel height** - We supply this system in three options - for doors up to 2100mm high, 2400mm high or 3300mm high (different kits are supplied with different length flush bolts).

Track Details:

- Supplied with 1 x 4000mm length aluminium track (can be cut to length on site).
- 50mm wide x 50mm depth.

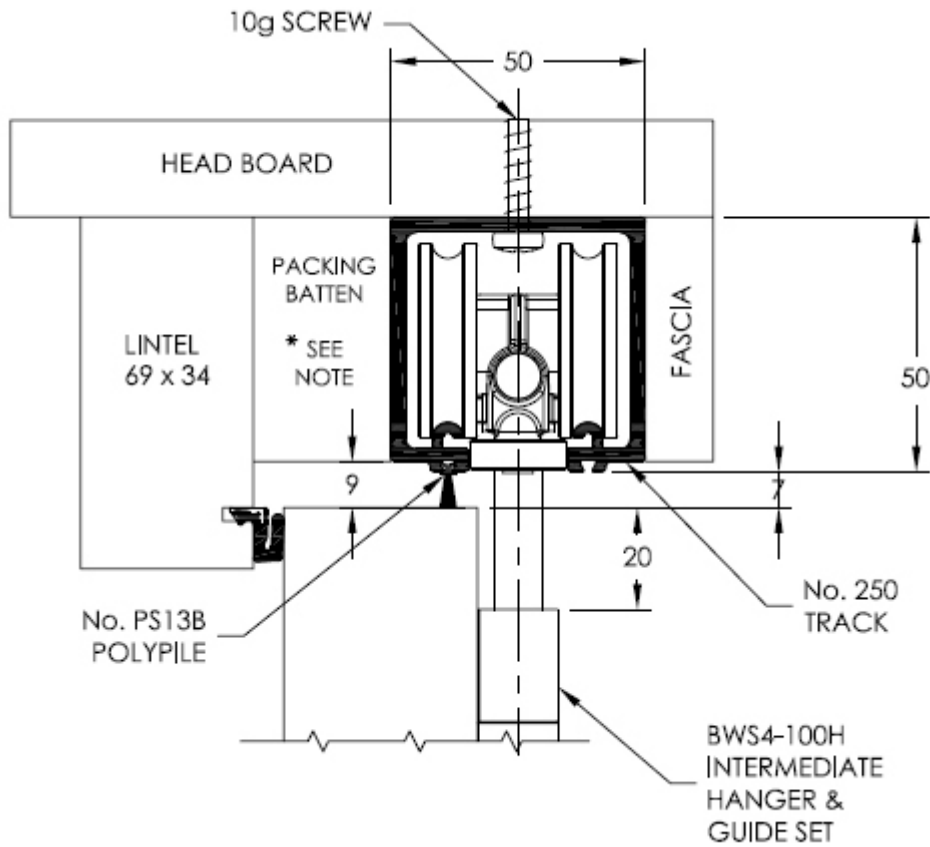

Bottom Channel Details:

- Supplied with 1 x 2500mm length anodised aluminium with black Polypropylene insert.
- 20mm depth x 21mm width.

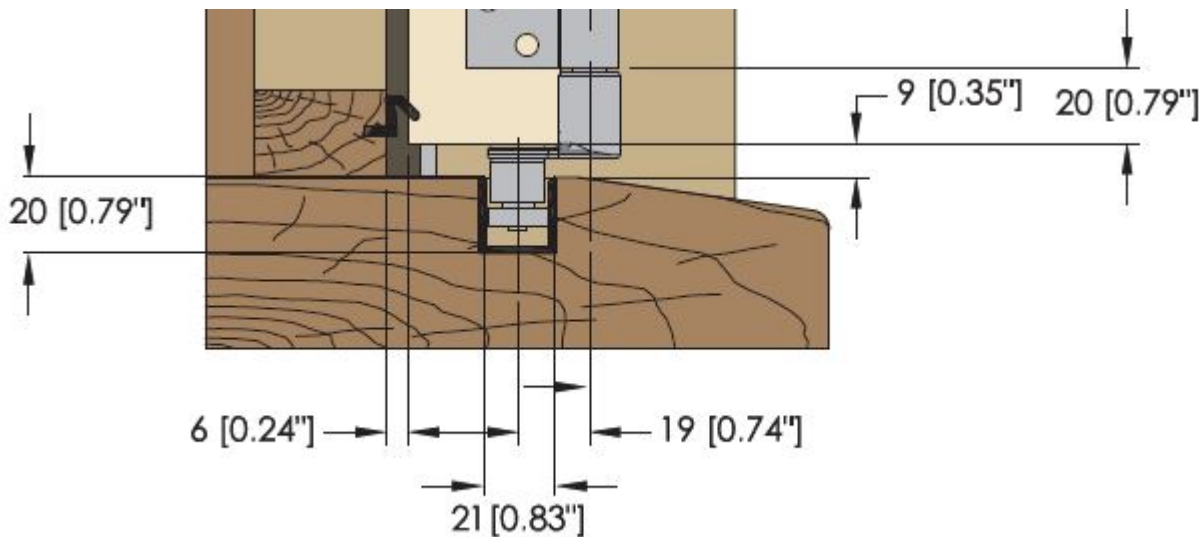

Hanger Details:

Easy adjustment for faster installation, the locking mechanism provides easy vertical adjustment. Just simply depress the push button and lower or raise the panel using the hex key provided.

Featuring automatic locking technology, the system self locks as soon as the push button is released, ensuring that the panel always remains set.

The locking mechanism is concealed within the track to offer greater visual appeal.

The intermediate hanger hinge, bottom guides and pivot now feature non-removal pin technology for enhanced security. No exterior hardware can be

tampered with or removed.

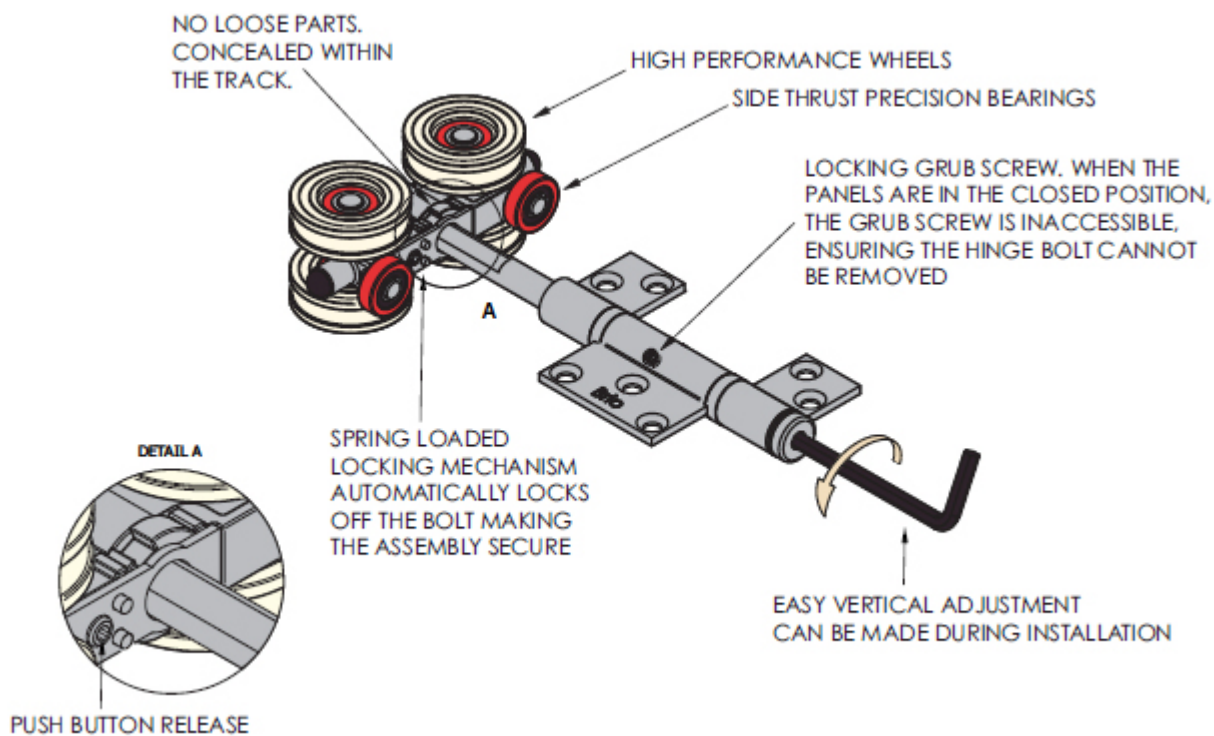

Hinges:

- Supplied with non mortice hinges.
- Surface mounted fitting,
- Highly versatile, suitable for timber panels and aluminium panels.
- Accommodates panels 35-68mm thick. Shown below on a 40mm thick panel.
- Hinge size: 100mm high x 66mm wide x 3mm thick.
- Made from satin stainless steel - satin (brushed) finish.

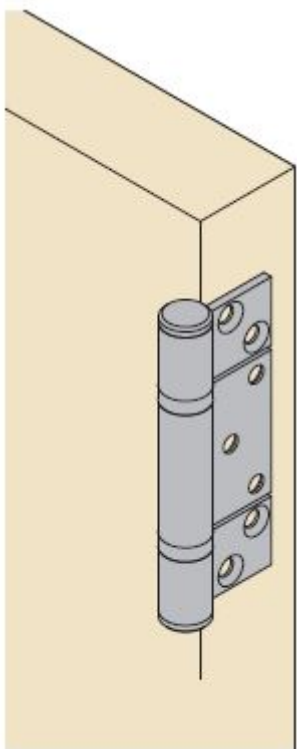

Security Aligner:

- The 199SS security aligner is included with all of our Brio Weatherfold systems.
- This discreet product pulls the pivot door onto the frame to seal as the door rotates shut.
- The 199SS Security Aligner is concealed and inaccessible when the doors are closed for additional tamperproof security.

Durability:

- Nothing carries the Brio Brand without undergoing a rigorous test program.
- A proven performer, Weatherfold 4s is no exception. All components of Weatherfold 4s have passed endurance tests, so you can rest assured that Weatherfold 4s is built to last.

Corrosion resistance:

- Weatherfold 4s has completed extensive corrosion resistance tests conducted in an industry standard salt spray chamber.
- Weatherfold 4s uses the highest quality corrosion resistant materials. All components are constructed using 300 series stainless steel, with the cast items in 316 grade.
- Brio is one of only a few global companies to passivate all visual stainless steel surfaces and electro-polish all cast stainless components.
- These processes greatly reduce and eliminate surface discolouration often referred to as 'tea-staining'.

Finish Details:

- **Hardware / Ironmongery** - Satin stainless steel.
- **Top Track** - Aluminium
- **Bottom Channel** - Aluminium with black Polypropylene insert.
- **Track & Door Seals** - Brown

Alternative Finishes Available (Contact Us To Order):

- **Hardware / Ironmongery** - Polished stainless steel / PVD brass / PVD black.
- **Track & Door Seals** - White

Hardware Layout:

- Please note below images may not represent configuration of this particular kit and are only to be used as an example of where the hardware is fitted.

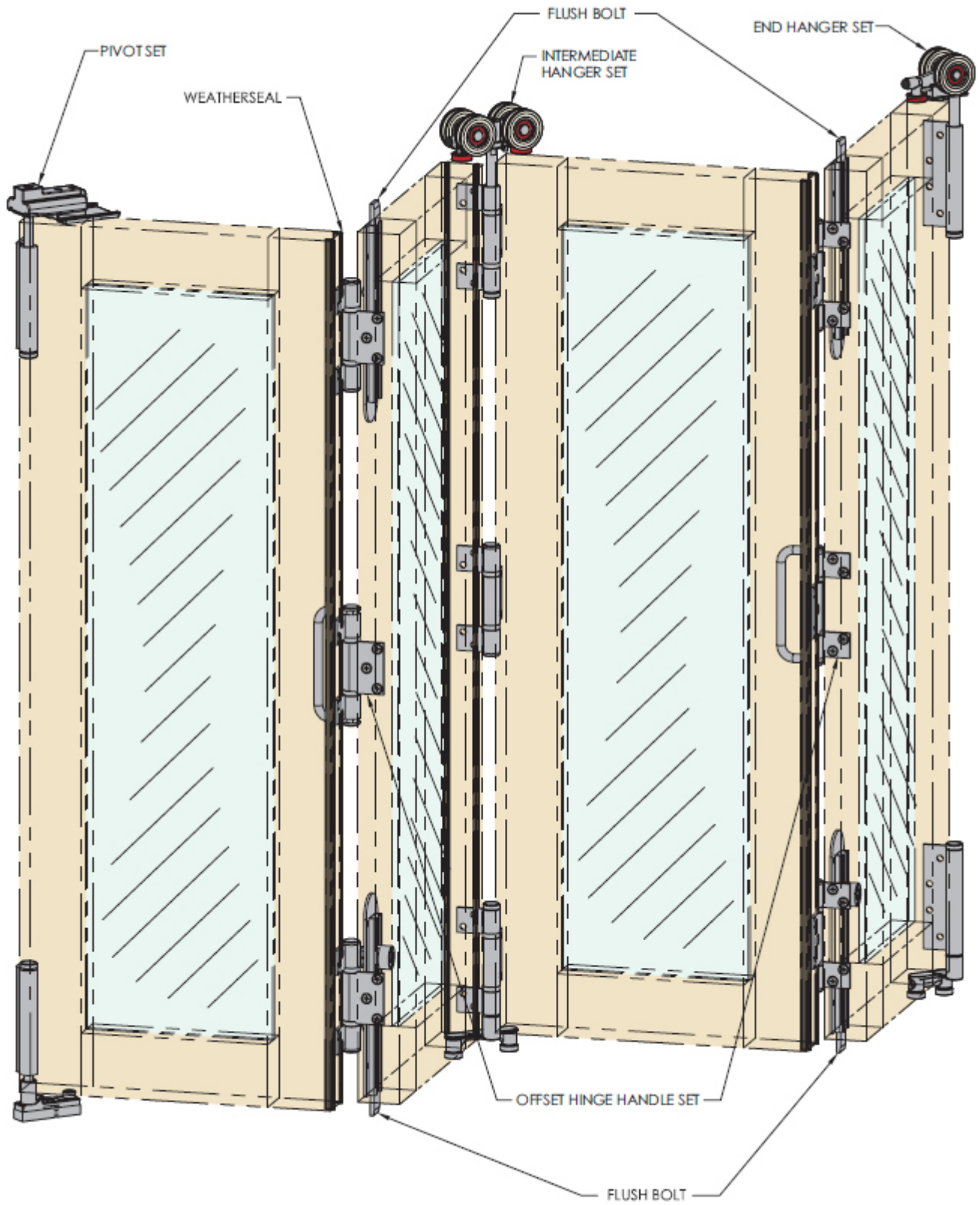

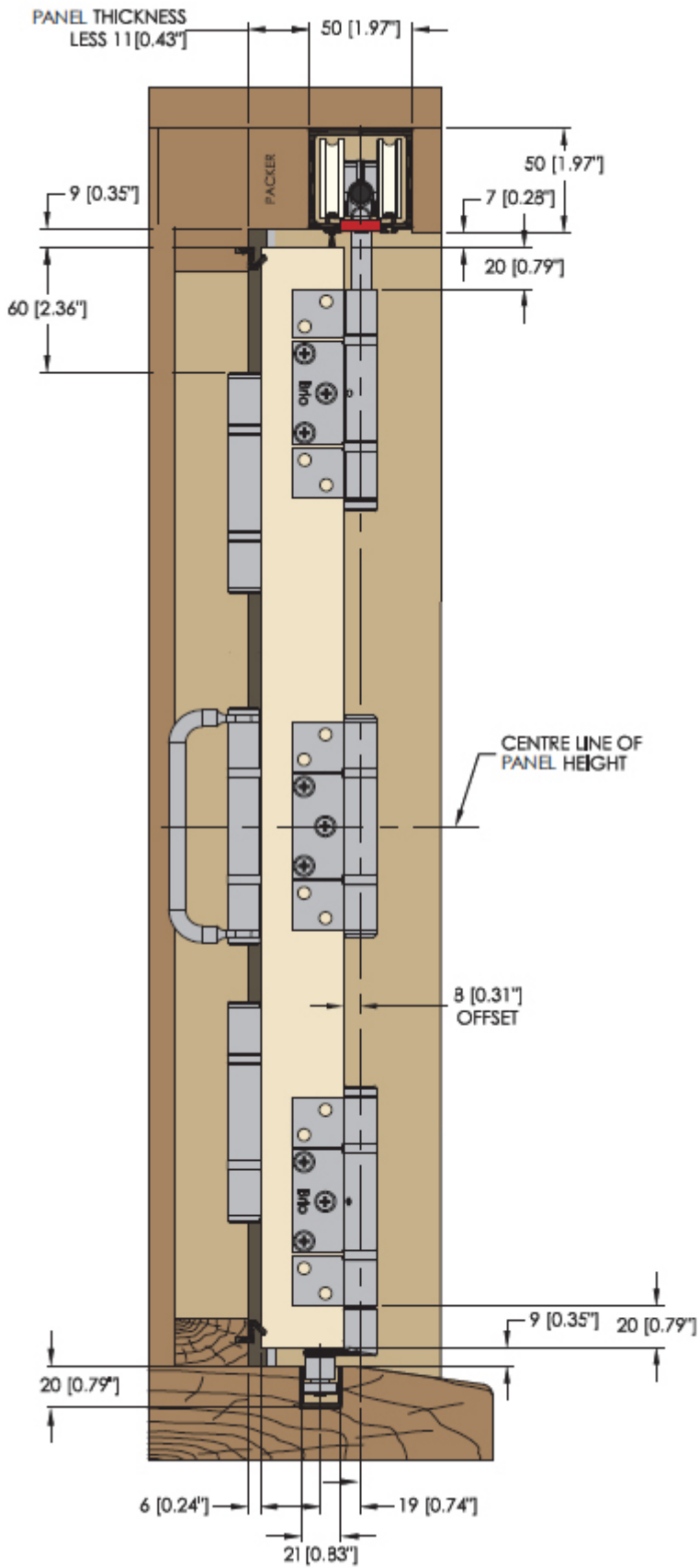

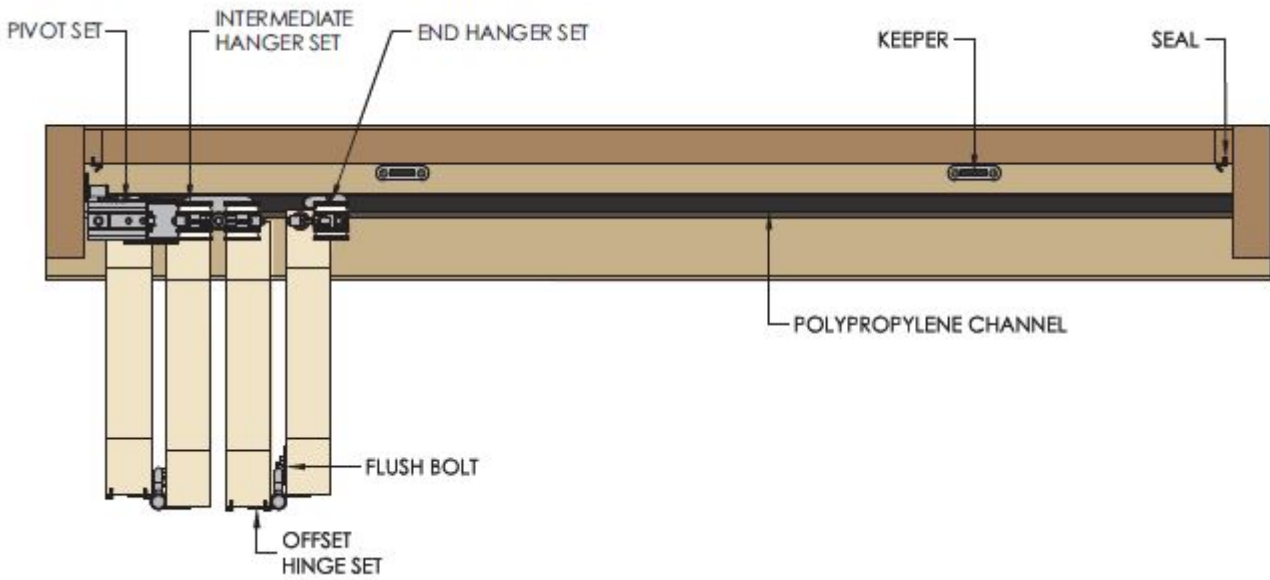

Clearance Requirements:

- **Head Clearance** - 7mm
- **Sill Clearance** - 9mm
- **Jamb Clearance** - 6mm
- **Clearance Between Panels** - 4mm

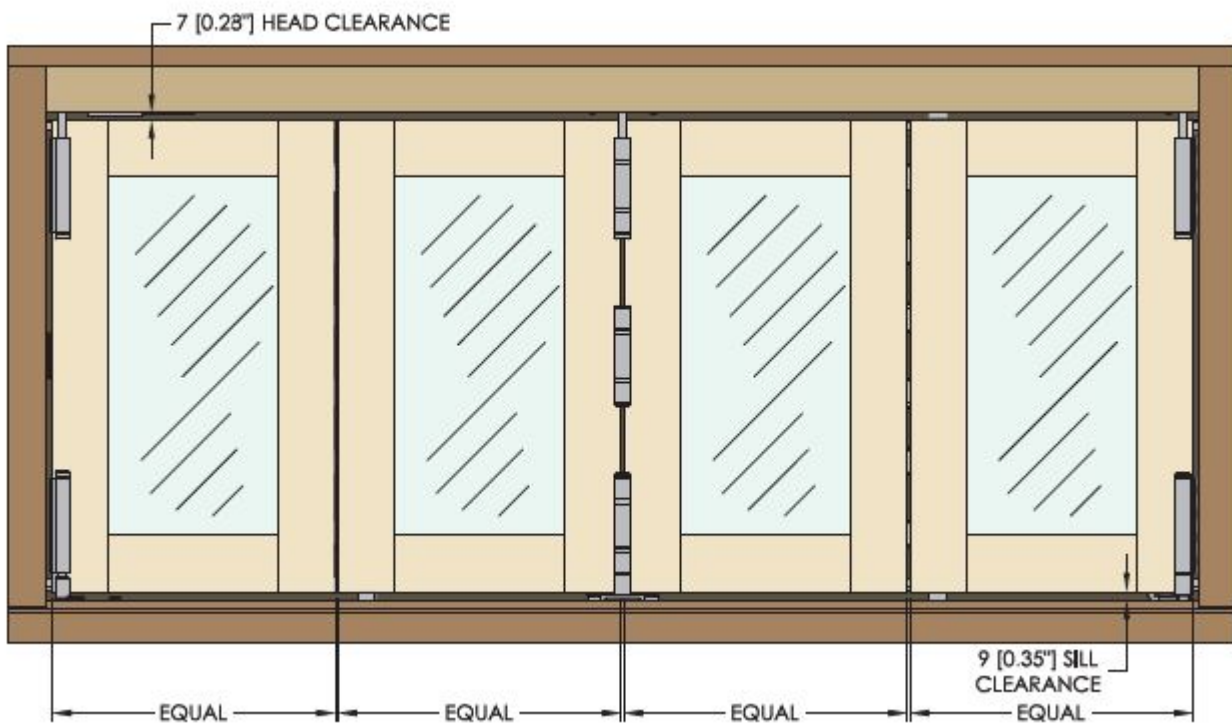

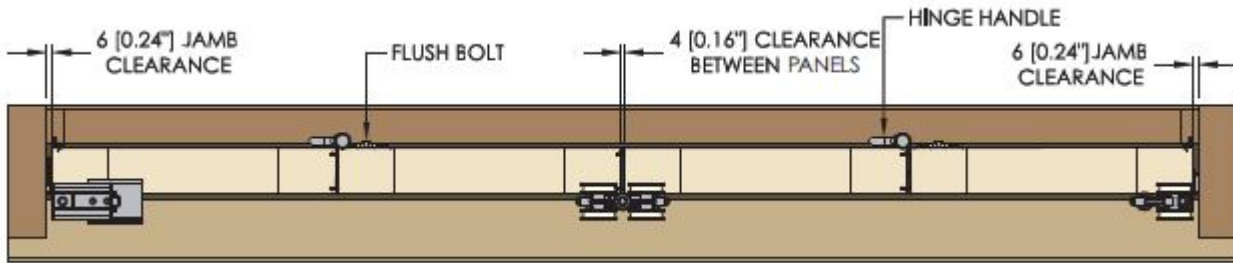

Meeting Panel Configuration:

- End panel to end panel configuration with non-non mortise hinges and square (plain) edge doors.
- For **rebated** door panels please contact us as alternative hardware needs to allowed for.

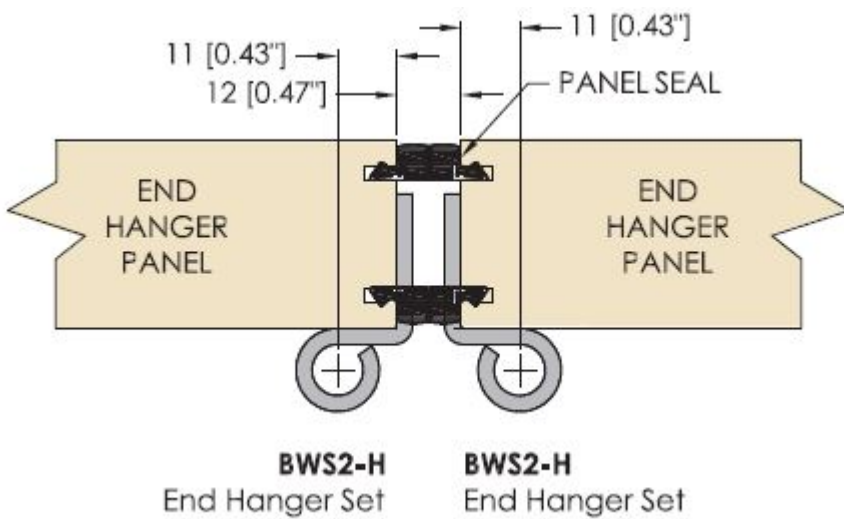

- End panel to swing configuration with non-non mortise hinges and square (plain) edge doors.
- For **rebated** door panels please contact us as alternative hardware needs to allowed for.

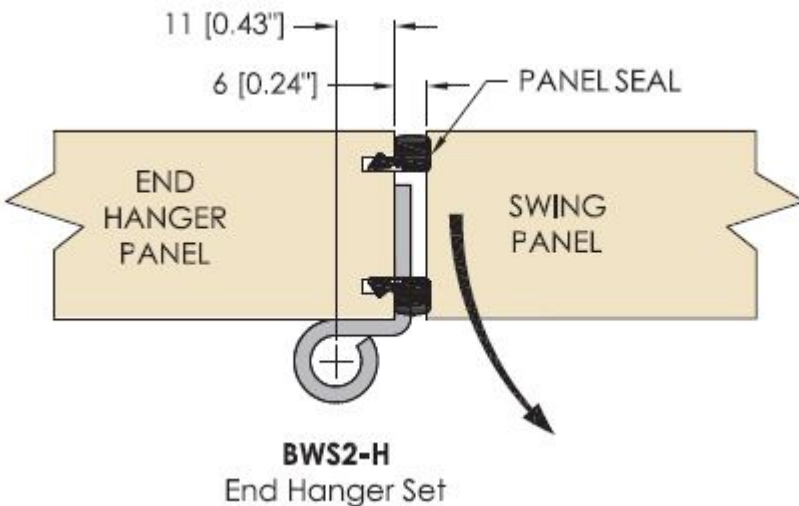

Flush Bolts:

- Supplied with satin stainless steel flush bolts (alternative finishes available to order).
- Non locking top bolts and key locking bottom bolts supplied where required in each kit.
- Flush bolts are an essential aid in obtaining an even perimeter seal pressure as well as extra security for the panel.

- Included within our Brio kit for inward opening doors are special cranked flush bolts for the top of the door and rounded through bottom bolts,

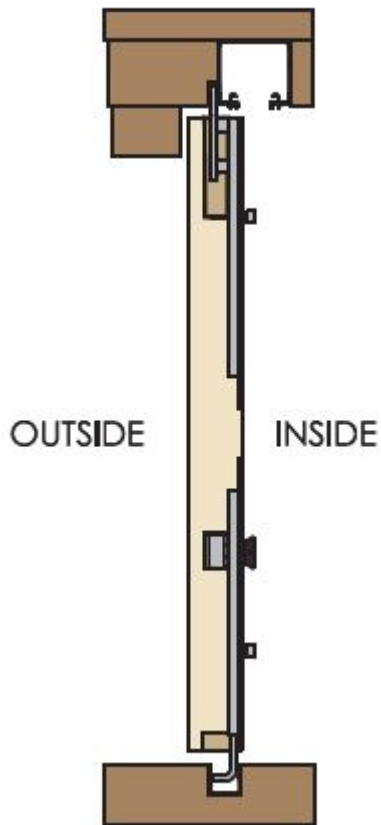

Top Flush Bolt Dimensions:

- Top Flush Bolt Width - 41mm
- Top Flush Bolt Depth - 16mm
- Top flush bolt length supplied with the 2100mm high kit - 190mm
- Top flush bolt length supplied with the 2400mm high kit - 450mm
- Top flush bolt length supplied with the 3300mm high kit - 600mm
- Non lockable top bolts supplied within each kit.

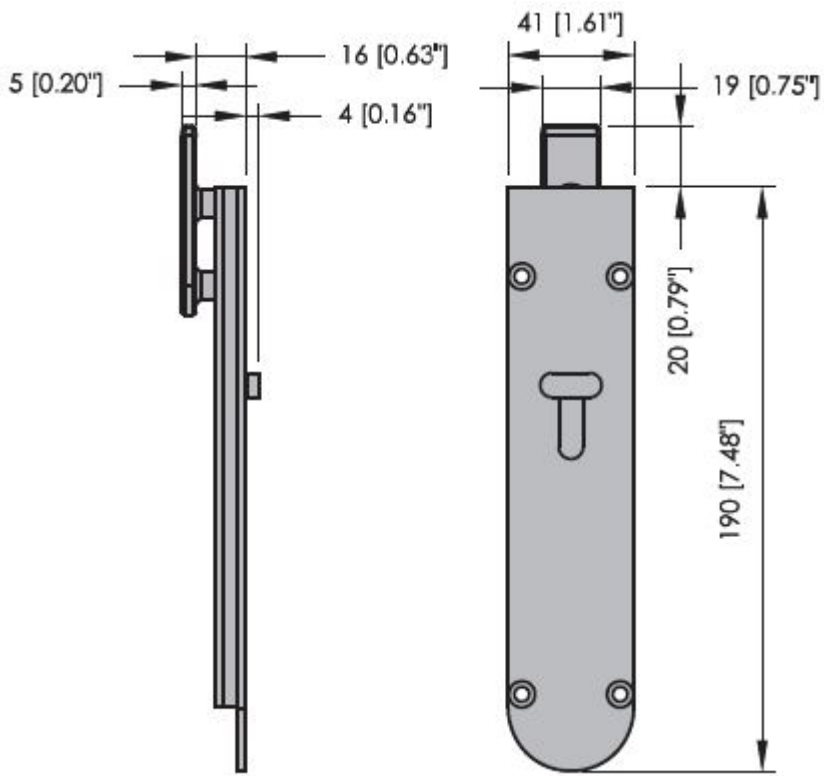

Bottom Flush Bolt Dimensions:

- Bottom flush bolt width - 41mm
- Bottom flush bolt depth - 21mm
- Bottom flush bolt length supplied with all kits - 190mm
- **Key lockable bottom bolt supplied.**

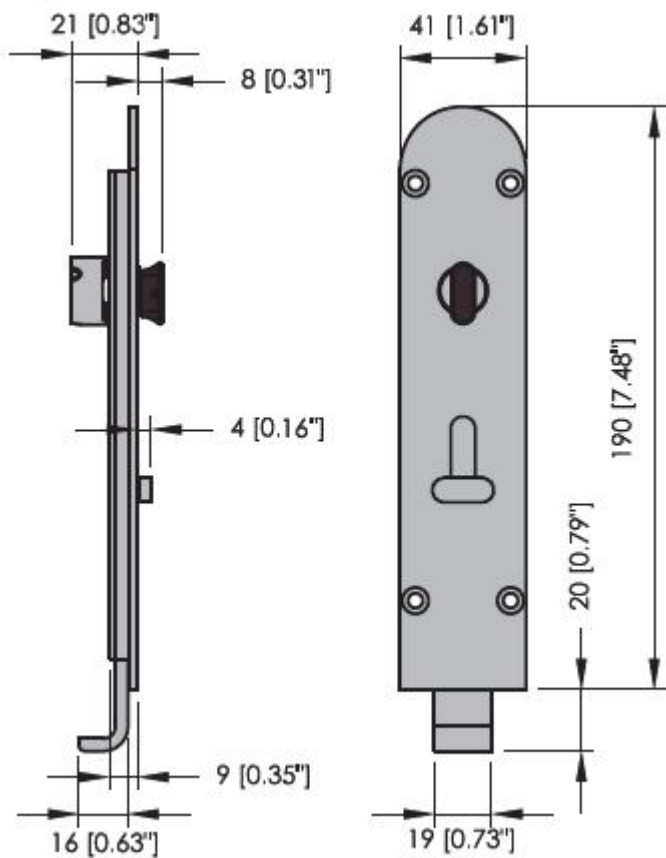

Weather Seals:

- Our Brio bi-folding door kits are supplied as standard with **brown** seals - (white seals are available to order).
- Supplied with Schlegel Aquamac AQ21 foam seals (brown finish) for the frame and sill.

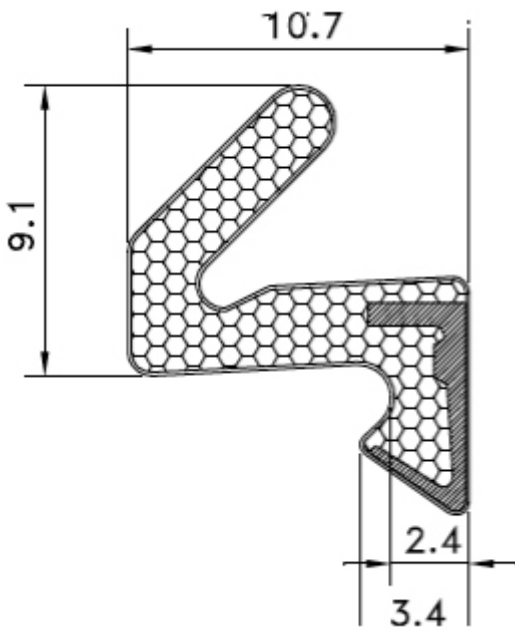

- Supplied with Schlegel Aquamac AQ63 foam seals (brown finish) for the door panels.

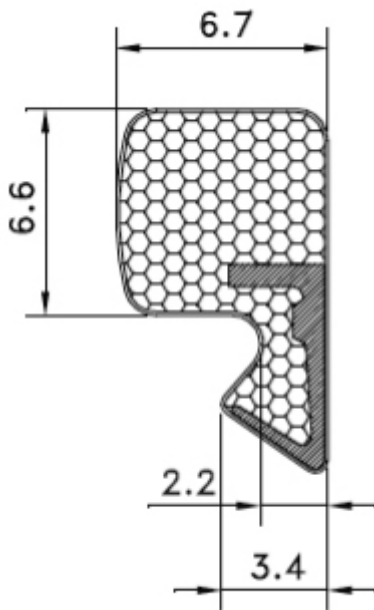

- Supplied with PS13B brush seals for the top track to seal the gap at the top of the door.



Items Not Included - To Be Purchased Separately:

- Timber / wooden doors.
- Locking mechanism - hook lock, claw lock or multi-point locks.
- Door handles.

Items Supplied Within This Bi-Folding Door Kit:

- Top track.
- Bottom channel.
- Hangers and guides.
- Hinges and security aligner bolt.
- Top flush bolts - (non locking).
- Bottom flush bolts - (key locking).
- Seals for frames, doors, and track.

Products in this set



41307.1 - Brio Weather Fold 4S - Inward Opening External Bi-Folding Doors - 2100mm High - 5 + 1 System



41307.2 - Brio Weather Fold 4S - Inward Opening External Bi-Folding Doors - 2400mm High - 5 + 1 System



41307.3 - Brio Weather Fold 4S - Inward Opening External Bi-Folding Doors - 3300mm High - 5 + 1 System