

---

## Beehive Design Cupboard Door Knob - Two Sizes Available - Rosewood & Polished Nickel

### Product Images

---



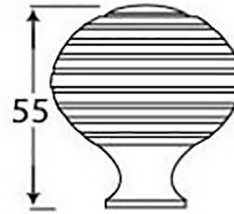
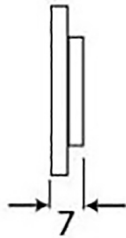
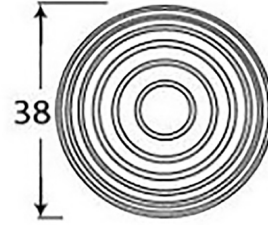
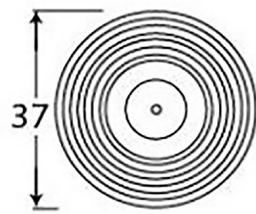

## Description

---

- Beehive Design cupboard door Knob with a wooden knob and solid brass rose
- They are suitable for cupboards, doors and drawers
- High architectural quality range

## Size Details

- Available in 2 sizes

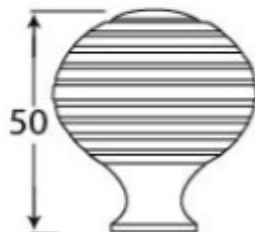
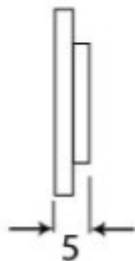
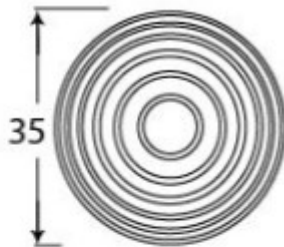
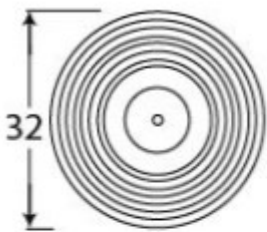

- Overall Size: 35mm Diameter
- Base Size: 32mm Diameter
- Projection: 50mm

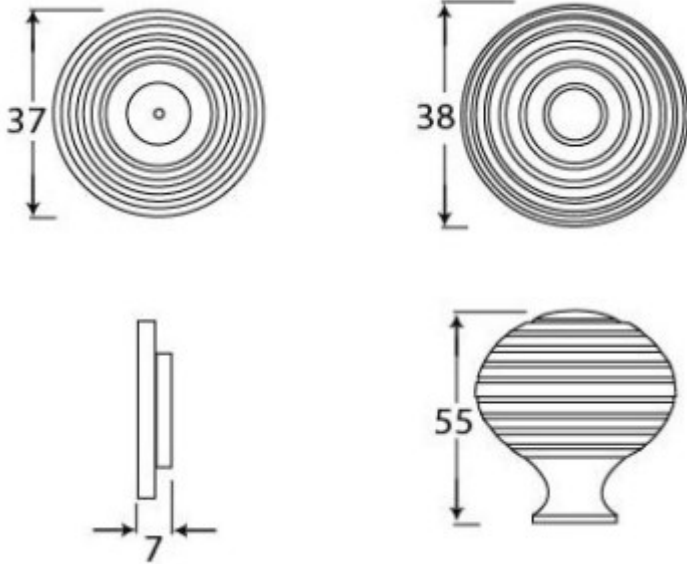

- Overall Size: 38mm Diameter
- Base Size: 37mm Diameter
- Projection: 55mm

## Base Material

- Rosewood Knob & Solid Brass Rose

## Finish Details

- Rosewood & Polished Nickel

## Fixings

- This cupboard knob is fitted via a M4 bolt from the rear of the door / drawer - see below diagram

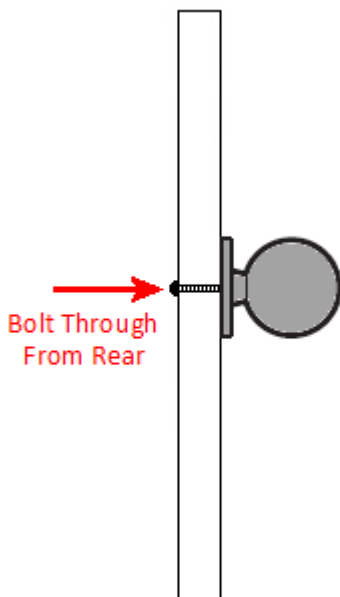

- Bolt through fixings provide a superior strong fixing allowing this knob to be fitted to tall or heavy doors
- Comes supplied with a 31mm long bolt - suitable for use on 18mm thick doors
- For doors thicker than 18mm, longer M4 fixing bolts are available to buy separately (See related products below)

## Alternative Fixings

- For fixing two cupboard Knob back to back on either side of a door, a length of M4 stud is required to screw the two Knob together
- For face fixing a cupboard knob by screwing it directly into the front of a wooden door or drawer, a dual M4 / Wood screw is required

## Usage

- Suitable for internal use
- For doors thicker than 18mm please purchase longer M4 fixing bolts (See related products below)

## Unit Of Sale

- These cupboard Knob are sold individually - Each

### Products in this set

---



49244.1 - Beehive Design Cupboard Door Knob - 35mm Diameter - Rosewood & Polished Nickel - Each



49244.2 - Beehive Design Cupboard Door Knob - 38mm Diameter - Rosewood & Polished Nickel - Each