

Hammered Mushroom Design Cupboard Door Knob - Two Sizes Available - Polished Solid Bronze

Product Images

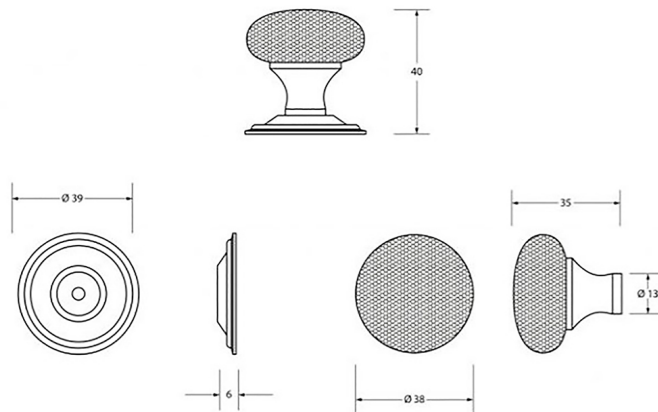

Description

- Hammered Mushroom Design cupboard door Knob
- They are suitable for cupboards, doors and drawers
- High architectural quality range

Size Details

- Available in 2 sizes

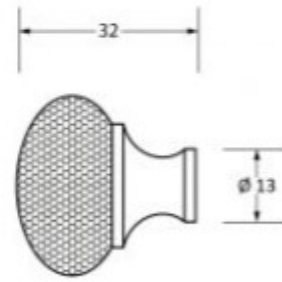
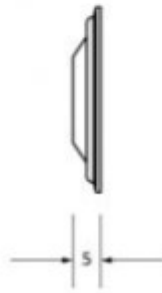
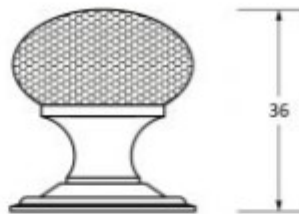

- Overall Size: 32mm Diameter
- Base Size: 33mm Diameter
- Projection: 36mm

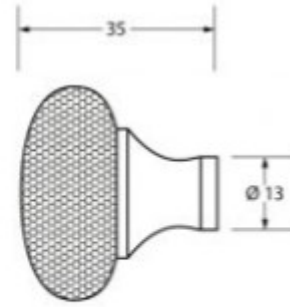
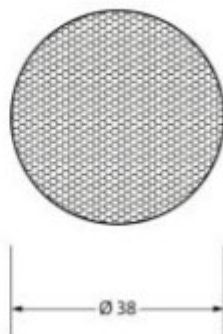
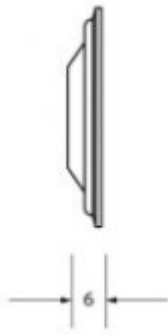
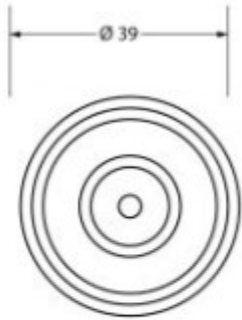
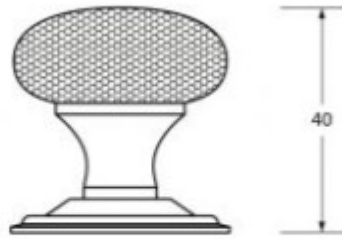

- Overall Size: 38mm Diameter
- Base Size: 39mm Diameter
- Projection: 40mm

Base Material

- Bronze

Finish Details

- Polished Bronze

Fixings

- This cupboard knob is fitted via a M4 bolt from the rear of the door / drawer - see below diagram

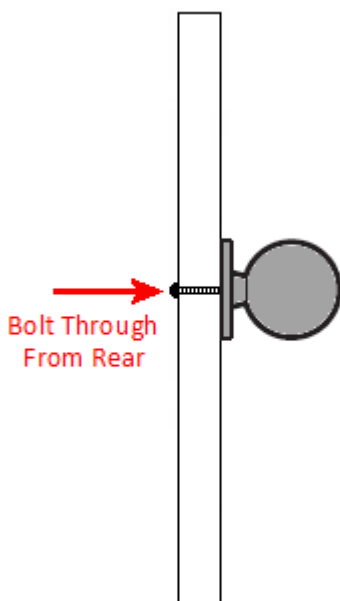

- Bolt through fixings provide a superior strong fixing allowing this knob to be fitted to tall or heavy doors
- Comes supplied with a 31mm long bolt - suitable for use on 18mm thick doors
- For doors thicker than 18mm, longer M4 fixing bolts are available to buy separately (See related products below)

Alternative Fixings

- For fixing two cupboard Knob back to back on either side of a door, a length of M4 stud is required to screw the two Knob together
- For face fixing a cupboard knob by screwing it directly into the front of a wooden door or drawer, a dual M4 / Wood screw is required

Usage

- Suitable for internal use
- For doors thicker than 18mm please purchase longer M4 fixing bolts (See related products below)

Unit Of Sale

- These cupboard Knob are sold individually - Each

Products in this set



49249.1 - Hammered Mushroom Design Cupboard Door Knob - 32mm Diameter - Polished Solid Bronze
- Each



49249.2 - Hammered Mushroom Design Cupboard Door Knob - 38mm Diameter - Polished Solid Bronze
- Each